









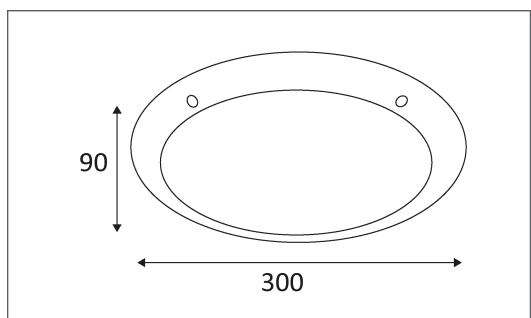

TIMY LED



Applique murale ou plafonnier en polycarbonate.
 Equipé d'un module LED 9W 3000K 810Lm ou 15W 4000K 1200Lm.
 Livré avec clé et vis anti-vandale.
 Convertisseur intégré (non dimmable).

Code	Couleur	AC/DC	LED	T° (K)	Lumen
TP1139WW20	METAL	AC 230V	9W	3000K	810 Lm
TP1139WW30	NOIR	AC 230V	9W	3000K	810 Lm
TP1139WW31	BLANC	AC 230V	15W	4000K	1200 Lm



PICTO	Description
	Montage sur un mur ou un plafond.
	Etanchéité aux poussières. Etanchéité aux jets d'eau puissants.
	Résistance : 20 Joule
	Produit dont les parties accessibles sont séparées des parties actives par double isolation ou isolation renforcée.
	Homologation CE.
	Alimentation électronique incluse.
	A connecter à un courant alternatif de 230 volts.