



PYXO-T E27







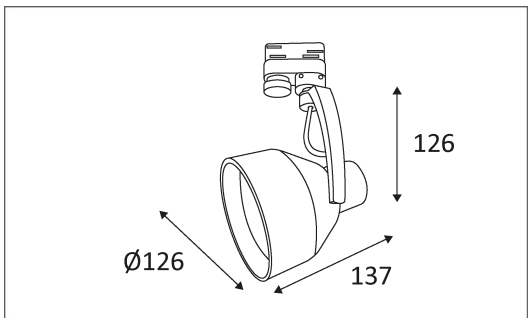





Projecteur orientable équipé d'un adaptateur pour rail TRI.
 Equipé d'une douille E27 pour 1 PAR30 100W max.
 Ne nécessite pas de transformateur.

Code	Couleur	Socket	AC/DC	Watt Max	Lampe/Lamp
18532AA20	ARGENT	E27	AC 230V	100W	PAR30
18532AA31	BLANC	E27	AC 230V	100W	PAR30



PICTO Description

-  Montage au plafond uniquement.
-  Usage intérieur uniquement.
-  Protection contre la pénétration de corps supérieurs à 12mm. Sans protection contre l'eau.
-  Luminaire à isolation principale qui comporte des dispositifs reliant l'ensemble de ses parties métalliques accessibles au conducteur de protection.
-  Homologation CE.
-  Orientation verticale possible du luminaire pour un maximum de 90°.
-  Orientation horizontal possible du luminaire pour un maximum de 355°.
-  Montage sur surfaces inflammables.
-  Distance minimale des objets illuminés (0,5 m)
-  Ne nécessite pas de transfo/ballast
-  A connecter à un courant alternatif de 230 volts.