

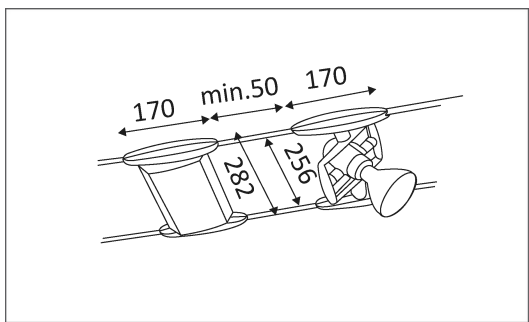









## FOCUS Q E27



Luminaire pour câble tendu 230V.  
Orientable horizontalement et verticalement.  
Equipé d'une douille E27 pour 1 CDM-R 70W.  
Ballast électronique intégré dans un boîtier séparé et se placant sur le câble à minimum 5 cm du luminaire.

Code	Couleur	Socket	AC/DC	Watt Max	Lampe/Lamp	
MZ315728	GRIS	E27	AC 230V	70W	CDM-R	 E



PICTO	Description
	Usage intérieur uniquement.
	Protection contre la pénétration de corps supérieurs à 12mm. Sans protection contre l'eau.
	Produit dont les parties accessibles sont séparées des parties actives par double isolation ou isolation renforcée.
	Homologation CE.
	Orientation vertical possible du luminaire pour un maximum de 350°.
	Alimentation électronique incluse.
	Montage sur surfaces inflammables.
	Distance minimal des objets illuminés (0,8 m)
	A connecter à un courant alternatif de 230 volts.
	Courbe photométrique disponible sur le site web.