



## EFFY 330 E27







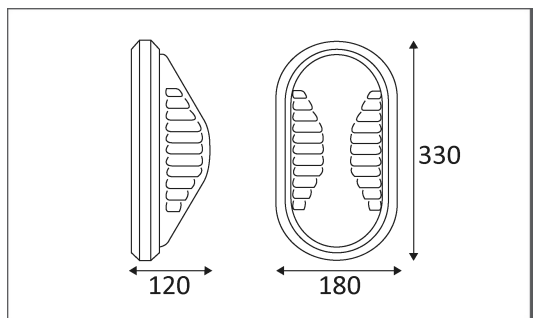



Applique murale ou plafonnier en thermoplastique renforcé de fibres de verre.  
 Equipé d'une douille E27 pour 1 QT-32 75W (ou ECO 15W).  
 Diffuseur opalin en polycarbonate.  
 Ne nécessite pas de transfo.

Code	Couleur	Socket	AC/DC	Watt Max	Lampe/Lamp
133400	BLANC	E27	AC 230V	15/75W	FBT/QT-32
133401	NOIR	E27	AC 230V	15/75W	FBT/QT-32



### PICTO Description

-  Montage sur un mur ou un plafond.
-  Etanchéité aux poussières. Protection contre les jets d'eau.
-  Résistance : 20 Joule
-  Produit dont les parties accessibles sont séparées des parties actives par double isolation ou isolation renforcée.
-  Homologation CE.
-  Ne nécessite pas de transfo/ballast
-  Montage sur surfaces inflammables.
-  A connecter à un courant alternatif de 230 volts.