



## EFFY 270 T E27







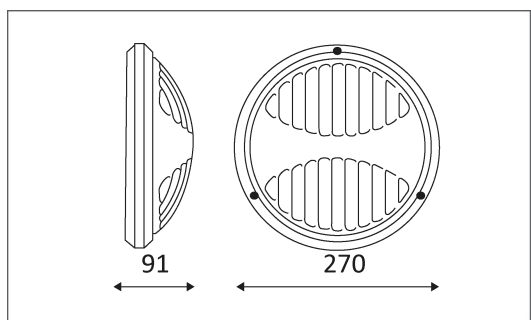



Applique murale ou plafonnier en thermoplastique renforcé de fibres de verre.  
 Equipé d'une douille E27 pour 1 QT-32 75W (ou ECO 15W).  
 Diffuseur opalin en polycarbonate.  
 Ne nécessite pas de transfo.  
 Vis "TORX" à commander séparément : ACVTORX2

Code	Couleur	Socket	AC/DC	Watt Max	Lampe/Lamp
127400	BLANC	E27	AC 230V	15/75W	FBT/QT-32
127401	NOIR	E27	AC 230V	15/75W	FBT/QT-32



### PICTO Description

-  Montage sur un mur ou un plafond.
-  Etanchéité aux poussières. Protection contre les jets d'eau.
-  Résistance : 20 Joule
-  Produit dont les parties accessibles sont séparées des parties actives par double isolation ou isolation renforcée.
-  Homologation CE.
-  Ne nécessite pas de transfo/ballast
-  Montage sur surfaces inflammables.
-  A connecter à un courant alternatif de 230 volts.

### Accessoires / Toebehoren

ACVTORX2 TORX VIS 1PCE

