











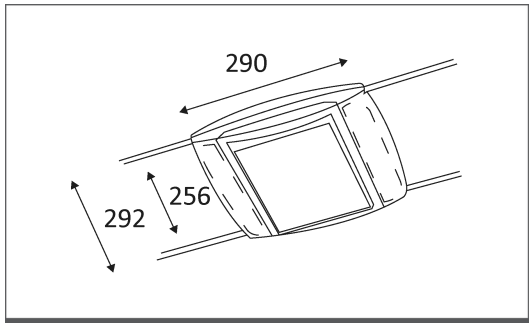

ECOLUCIS D FLUO



Luminaire pour câble tendu 230V.
 Corps en thermoplastique.
 Diffuseur "dark light" en aluminium.
 Equipé de douilles 2G10 pour 2 TCF de 36W.
 Ballast électronique intégré.
 Livré avec lampes.

Code	Socket	AC/DC	Watt Max	Lampe/Lamp	T° (K)	
MZ317536	2G10	AC 230V	2x36W	TCF	3000K	E



PICTO	Description
	Usage intérieur uniquement.
	Protection contre la pénétration de corps supérieurs à 12mm. Sans protection contre l'eau.
	Produit dont les parties accessibles sont séparées des parties actives par double isolation ou isolation renforcée.
	Homologation CE.
	Alimentation électronique incluse.
	Livré avec lampe(s).
	Montage sur surfaces inflammables.
	A connecter à un courant alternatif de 230 volts.
	Courbe photométrique disponible sur le site web.