











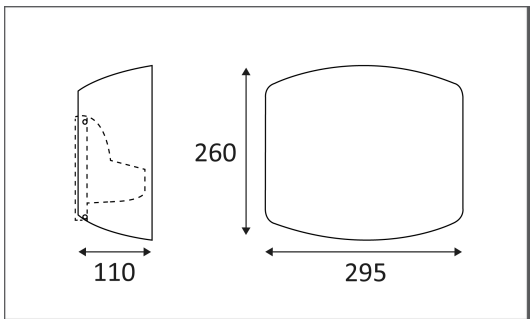

CRIO E27



Applique en verre opalin.
 Equipée d'une douille E27 pour 1 lampe 150W max.
 Ne nécessite pas de transformateur.

Code	Couleur	Socket	AC/DC	Watt Max	Lampe/Lamp
3762C150	BLANC	E27	AC 230V	150W	HE ECO



PICTO	Description
	Montage sur un mur uniquement.
	Usage intérieur uniquement.
	Protection contre la pénétration de corps supérieurs à 12mm. Sans protection contre l'eau.
	Produit dont les parties accessibles sont séparées des parties actives par double isolation ou isolation renforcée.
	Homologation CE.
	Montage sur surfaces inflammables.
	Ne nécessite pas de transfo/ballast
	A connecter à un courant alternatif de 230 volts.
	Courbe photométrique disponible sur le site web.