











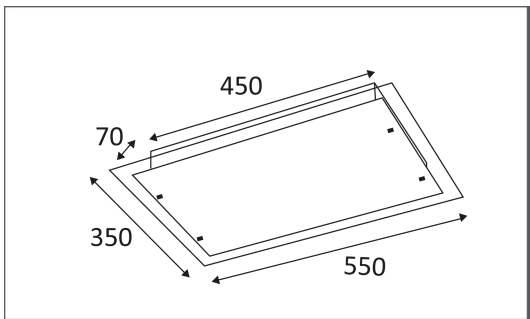

COME 09 FLUO



Applique ou plafonnier en aluminium et verre.
 Equipé de douilles 2G11 pour 2 FSD 36W.
 Ballast électronique intégré.

Code	Socket	AC/DC	Watt Max	Lampe/Lamp	
CO1409	2G11	AC 230V	2x36W	FSD	E



PICTO	Description
	Montage sur un mur ou un plafond.
	Usage intérieur uniquement.
	Protection contre la pénétration de corps supérieurs à 12mm. Sans protection contre l'eau.
	Luminaire à isolation principale qui comporte des dispositifs reliant l'ensemble de ses parties métalliques accessibles au conducteur de protection.
	Homologation CE.
	Montage sur surfaces inflammables.
	Alimentation électronique incluse.
	A connecter à un courant alternatif de 230 volts.
	Courbe photométrique disponible sur le site web.