



BONIE1 GU10







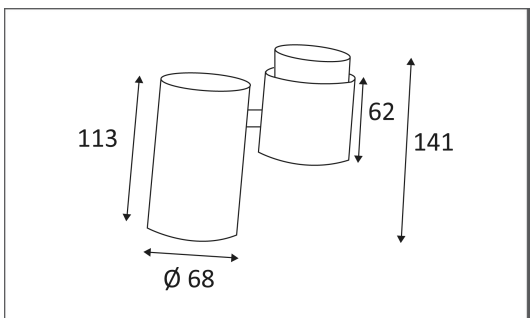





Plafonnier décoratif en fonte d'aluminium.
 Equipé d'une douille GU10 pour 1 PAR16 50W max.
 Ne nécessite pas de transformateur.

Code	Couleur	Socket	AC/DC	Watt Max	Lampe/Lamp
BA1464A16	BLANC	GU10	AC 230V	50W	PAR16
BA1464A28	ARGENT	GU10	AC 230V	50W	PAR16



PICTO Description

-  Montage au plafond uniquement.
-  Usage intérieur uniquement.
-  Protection contre la pénétration de corps supérieurs à 12mm. Sans protection contre l'eau.
-  Luminaire à isolation principale qui comporte des dispositifs reliant l'ensemble de ses parties métalliques accessibles au conducteur de protection.
-  Homologation CE.
-  Orientation du luminaire possible dans plusieurs sens.
-  Montage sur surfaces inflammables.
-  Distance minimale des objets illuminés (0,5 m)
-  Luminaires conçus pour être utilisés uniquement avec des lampes halogènes autoprotégées.
-  Ne nécessite pas de transfo/ballast
-  A connecter à un courant alternatif de 230 volts.