









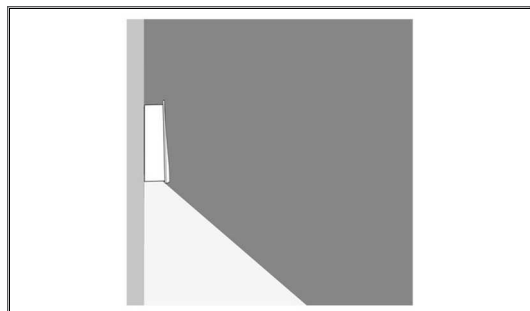
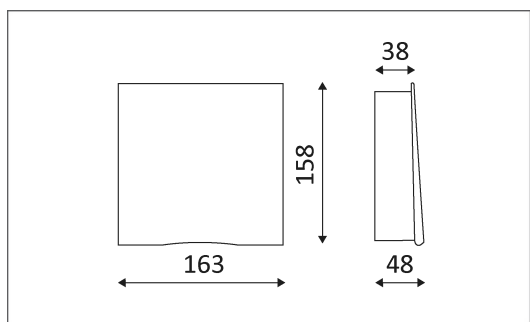

BALTI LED



Applique murale en fonte d'aluminium.
 Equipée d'un module LED 26W 2500Lm 3000K.
 Faisceau 110°.
 Convertisseur électronique intégré. (non dimmable).

Code	Couleur	AC/DC	LED	T° (K)	Lumen	α
118304	BLANC	AC 230V	26W	3000 K	2500 Lm	110°



PICTO	Description
	Montage sur un mur uniquement.
	Montage sur un mur uniquement.
	Etanchéité aux poussières. Etanchéité aux jets d'eau puissants.
	Luminaire à isolation principale qui comporte des dispositifs reliant l'ensemble de ses parties métalliques accessibles au conducteur de protection.
	Homologation CE.
	Alimentation électronique incluse.
	Montage sur surfaces inflammables.
	A connecter à un courant alternatif de 230 volts.