



CICLO 2 MONO LED







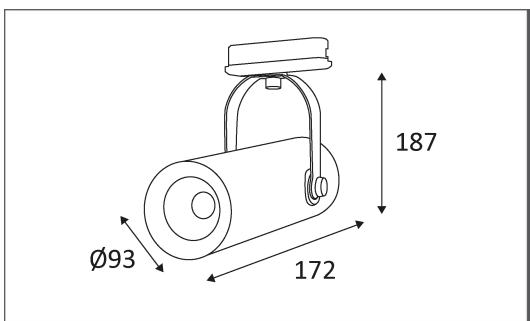







Projecteur orientable pour rail MONO.
Module LED 20W 1670Lm 4000K. Faisceau 24°.
Convertisseur non dimmable 350mA intégré.
IRC >80. Durée de vie 35.000 heures.

Code	Couleur	AC/DC	LED	T° (K)	Lumen	α
TR10825	ARGENT	AC 230V	20W	4000K	1670 Lm	24°
TR10830	NOIR	AC 230V	20W	4000K	1670 Lm	24°
TR10831	BLANC	AC 230V	20W	4000K	1670 Lm	24°



PICTO Description

-  Montage au plafond uniquement.
-  Usage intérieur uniquement.
-  Protection contre la pénétration de corps supérieurs à 12mm. Sans protection contre l'eau.
-  Luminaire à isolation principale qui comporte des dispositifs reliant l'ensemble de ses parties métalliques accessibles au conducteur de protection.
-  Homologation CE.
-  Distance minimal des objets illuminés (0,3 m)
-  Montage sur surfaces inflammables.
-  Power LED's. Ne pas fixer le faisceau lumineux, aux risques d'abîmer les yeux.
-  Orientation verticale possible du luminaire pour un maximum de 90°.
-  Orientation horizontale possible avec un maximum de 350°.
-  Alimentation électronique incluse.
-  A connecter à un courant alternatif de 230 volts.
-  Courbe photométrique disponible sur le site web.